

WPTLED40W/D10/PC2 USA



High performance LED wallpack. Covers footprint of most HID Wallpacks. Vandal resistant lens. Precision die-cast aluminum. 0-10V dimmable driver with 120-277V photocell.

Color: White

Weight: 6.5 lbs

Project:	Type:
Prepared By:	Date:

Driver Info		LED Info	
Type:	Constant Current	Watts:	40W
120V:	0.322A	Color Temp:	5000K (Cool)
208V:	0.202A	Color Accuracy:	75 CRI
240V:	0.175A	L70 Lifespan:	100000
277V:	0.147A	Lumens:	4021
Input Watts:	38W	Efficacy:	105 LPW
Efficiency:	N/A		

Technical Specifications

Listings

UL Listing:

Suitable for wet locations. Wall mount only.

IESNA LM-79 & LM-80 Testing:

RAB LED luminaires and LED components have been tested by an independent laboratory in accordance with IESNA LM-79 and LM-80.

LED Characteristics

Lifespan:

100,000-hour LED lifespan based on IES LM-80 results and TM-21 calculations

LEDs:

Long-life, high-efficacy surface mount LEDs

Color Stability:

LED color temperature is warranted to shift no more than 200K in CCT over a 5 year period

Color Uniformity:

RAB's range of CCT (Correlated Color Temperature) follows the guidelines of the American National Standard for Specifications for the Chromaticity of Solid State Lighting (SSL) Products, ANSI C78.377-2017.

Electrical

Drivers:

Constant Current, Class 2, 900mA, 100-277V, 50-60Hz, 120V: 0.322A, 208V: 0.202A, 240V: 0.175A, 277V: 0.147A, Surge Protection: 6kV

Power Factor:

99.0% at 120V, 93.5% at 277V

THD:

11.9% at 120V, 14.2% at 277V

Dimming Driver:

0-10V dimming driver standard for ultimate flexibility. Use as on/off or utilize the 0-10V DC dimming circuit for controls.

Photocell:

Photocell is rated for 120V thru 277V. To disable, simply use the provide silicone rubber cap and cover.

Optical

BUG Rating:

B1 U4 G3

Construction

Ambient Temperature:

Suitable for -40°C (-40°F) to 40°C (104°F) ambient temperatures

Cold Weather Starting:

Minimum starting temperature is -40°C (-40°F)

Thermal Management:

Superior thermal management with die-cast aluminum heatsink

Housing:

Precision die-cast aluminum

Refractor Lens:

High-impact, diffuse, UV-stabilized polycarbonate

Mounting:

Three (3) 1/2" NPS conduit entry points (2 sides for through-feed, and bottom), and drilling template for easy wall box mounting

Reflector:

High-gloss white aluminum

Gaskets:

High-temperature silicone gaskets

Finish:

Formulated for high-durability and long lasting color

Green Technology:

Mercury and UV-free. RoHS compliant components. Polyester powder coat finish formulated without the use of VOCs or toxic heavy metals.

Other

Equivalency:

Equivalent to 100W Metal Halide/70W HPS

Warranty:

RAB warrants that our LED products will be free from defects in materials and workmanship for a period of five (5) years from the date of delivery to the end user, including coverage of light output, color stability, driver performance and fixture finish. RAB's warranty is subject to all terms and conditions found at

Patents:

The design of WPTLED is protected by patents pending in US, Canada, China, Taiwan and Mexico

WPTLED40W/D10/PC2 USA

Dimensions

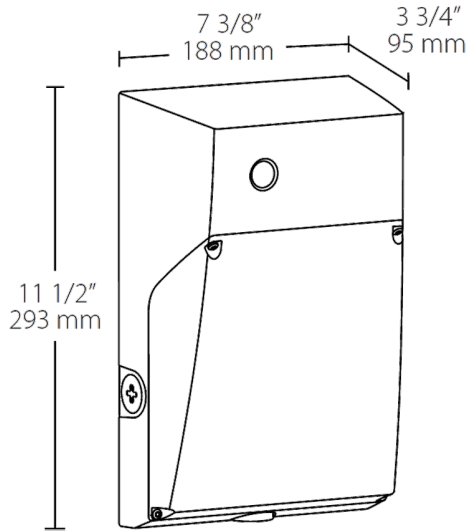

Features

- Covers footprints of most HID tallpacks
- 0-10V dimmable driver & 120 - 277V photocell
- Vandal-resistant lens
- 100,000-Hour LED lifespan

Ordering Matrix

Family	Wattage	Color Temp	Finish	Dimming	Photocell	Lightcloud	Other Options
WPTLED	40	^	W	/D10	/PC2	^	USA
	40 = 40W 25 = 25W 12 = 12W	Blank = 5000K (Cool) Y = 3000K (Warm) N = 4000K (Neutral)	Blank = Bronze W = White	/D10 = Dimmable	/PC2 = 120-277V Photocell	Blank = No Lightcloud /LC = Lightcloud Controller	USA = BAA Compliant Blank = Standard